

GENERAL COMPLIANCE

intended function, it can be installed below the flood elevation if it is anchored and protected.

304.5 GFCI protection. Electrical equipment installed below the design flood elevation shall be supplied by branch circuits that have ground-fault circuit interrupter protection for personnel.

❖ Electrical equipment that is installed below the design flood level, such as lighting, receptacle outlets and motorized pool covers, must be supplied by circuits that have ground-fault circuit interrupter (GFCI) protection.

SECTION 305 BARRIER REQUIREMENTS

305.1 General. The provisions of this section shall apply to the design of barriers for pools and spas. These design controls are intended to provide protection against the potential drowning and near drowning by restricting access to such pools or spas. These requirements provide an integrated level of protection against potential drowning through the use of physical barriers and warning devices.

Exceptions:

1. Spas and hot tubs with a lockable *safety cover* that complies with ASTM F1346.
2. Swimming pools with a powered *safety cover* that complies with ASTM F1346.

❖ Barriers around pools and spas significantly restrict unauthorized access to such pools and spas. The perimeter barrier design requirements in this section are especially focused on preventing children from having access to an area where the potential for drowning or near drowning is very high. Once children are inside the barrier perimeter, only constant adult supervision of those children can prevent drowning or near drowning. Thus, when adults choose to leave the pool and spa area, common sense dictates that all children should also leave the area and be taken outside of the perimeter barrier. Therefore, a thorough inspection of perimeter barriers is necessary, as they are the only required line of defense against drowning or near drowning of children when adults are not present.

The exceptions allow for spas and hot tubs with lockable covers complying with ASTM F1346 and pools with power safety covers complying with ASTM F1346 to not require barriers. A cover installed on a pool or installed on a spa or hot tub offers the same level of protection as a barrier, so barriers are not required. Commentary Figures 305.1(1) and 305.1(2) show powered safety covers on residential and public swimming pools, respectively. When covers are retracted or removed, only constant adult supervision of a pool and spa can prevent children from drowning or near drowning. Thus, when adults choose to leave the pool or spa area, common sense dictates that children are removed from the pool or spa and the cover installed immediately. Therefore, a thorough

inspection of covers, cover latching systems and cover deployment systems (and their operation) is necessary, as these covers are the only required line of defense against drowning or near drowning of children when adults are not present. Although the code is silent about the controls for electric-powered safety covers for pools, it is a reasonable assumption that care would be taken to keep the operating controls secured so only those persons responsible enough to not trap users in the pool would be operating the cover [see Commentary Figure 305.1(3)].

Note that a nonpowered pool cover (i.e., one that is manually installed) does not provide relief of the barrier requirement [see Commentary Figure 305.1(4)]. Even though a manual pool cover might comply with the requirements of ASTM F1346, installation of manually installed covers are time consuming and could be somewhat complicated such that they would not be used every time the pool was not in use.

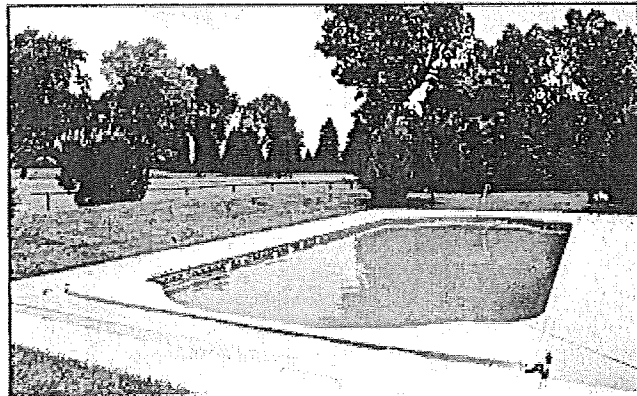

FIGURE 305.1(1)
ON-DECK-TYPE POWERED SAFETY COVER FOR
RESIDENTIAL POOL

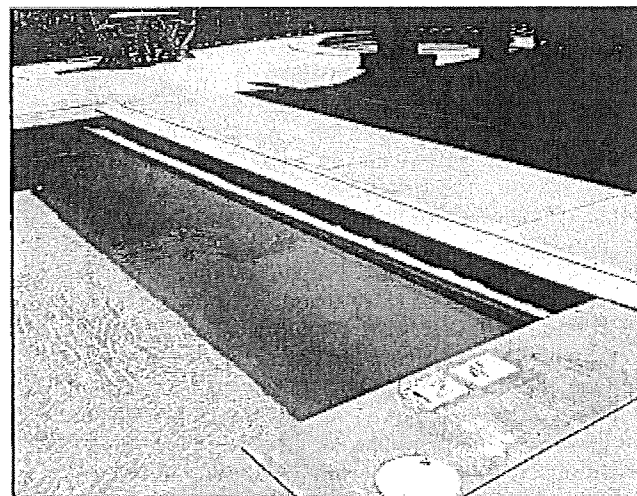

FIGURE 305.1(2)
INTEGRAL-TYPE POWERED SAFETY COVER FOR
PUBLIC POOL

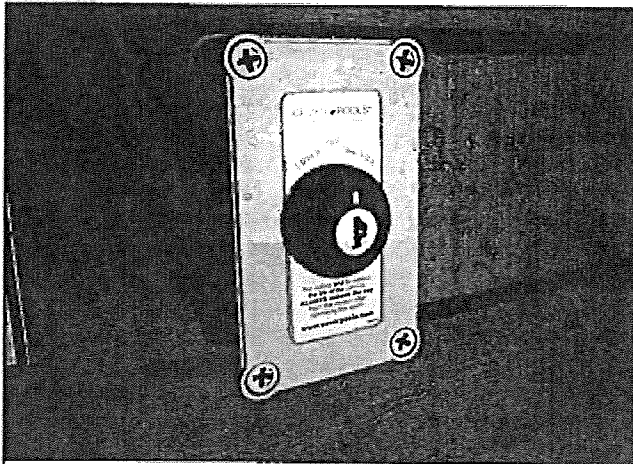

FIGURE 305.1(3)
KEY SWITCH FOR POWERED POOL COVER
OPERATION



FIGURE 305.1(4)
NONPOWERED MESH COVER DOES NOT ALLOW
FOR ABSENCE OF BARRIER AROUND POOL

305.2 Outdoor swimming pools and spas. Outdoor pools and spas and indoor swimming pools shall be surrounded by a barrier that complies with Sections 305.2.1 through 305.7.

❖ Sections 305.2 through 305.7 cover the requirements for barriers.

305.2.1 Barrier height and clearances. Barrier heights and clearances shall be in accordance with all of the following:

1. The top of the barrier shall be not less than 48 inches (1219 mm) above grade where measured on the side of the barrier that faces away from the pool or spa. Such height shall exist around the entire perimeter of the barrier and for a distance of 3 feet (914 mm) measured horizontally from the outside of the required barrier.
2. The vertical clearance between grade and the bottom of the barrier shall not exceed 2 inches (51 mm) for grade

surfaces that are not solid, such as grass or gravel, where measured on the side of the barrier that faces away from the pool or spa.

3. The vertical clearance between a surface below the barrier to a solid surface, such as concrete, and the bottom of the required barrier shall not exceed 4 inches (102 mm) where measured on the side of the required barrier that faces away from the pool or spa.
4. Where the top of the pool or spa structure is above grade, the barrier shall be installed on grade or shall be mounted on top of the pool or spa structure. Where the barrier is mounted on the top of the pool or spa, the vertical clearance between the top of the pool or spa and the bottom of the barrier shall not exceed 4 inches (102 mm).

❖ The barrier height of 48 inches (1219 mm) ensures that smaller children cannot simply "hop the fence" to gain access to the pool or spa. Those persons who are capable of climbing over a 48-inch-high (1219 mm) barrier are probably of sufficient maturity to avoid the pool if they cannot swim or are uncomfortable with the idea of entering the water of a spa. The height is measured on the outside of the barrier from the highest elevation of grade or concrete slab for a distance of 3 feet (914 mm) away from the outside of the barrier [see Commentary Figure 305.2.1(1)]. This requirement coordinates with Section 305.2.9 that requires a clear zone of 36 inches (914 mm) around the outside of the barrier.

Barriers that are not close to the surface of the ground could be bypassed by a child maneuvering under the barrier. Where over grass or gravel, the bottom of the barrier must be within 2 inches (51 mm) of the ground surface from which the grass grows from or onto which the gravel is placed. It is unlikely that a child would be able to dig out more than 2 inches (51 mm) of settled, naturally compacted earth in order to make an opening large enough to gain access to the pool or spa. If the bottom of the barrier is over concrete, the bottom must be within 4 inches (102 mm) of the concrete surface to prevent a child from maneuvering through the opening to gain access to the pool or spa [see Commentary Figures 305.2.1(2) and (3)].

The top of a pool or spa could be above grade. The barrier for this arrangement could be installed at grade or the barrier could be installed on top of the pool or spa [see Commentary Figure 305.2.1(4)]. Where mounted on top of the pool or spa, the vertical clearance from the top of the pool or spa to the underside of the barrier cannot exceed 4 inches (102 mm) [see Commentary Figure 305.2.1(5)] to prevent a child from maneuvering through the opening to gain access to the pool or spa.

305.2.2 Openings. Openings in the barrier shall not allow passage of a 4-inch diameter (102 mm) sphere.

❖ The 4-inch (102 mm) opening is narrow enough to prevent passage of a small child through the barrier (see Commentary Figure 305.2.2).

GENERAL COMPLIANCE

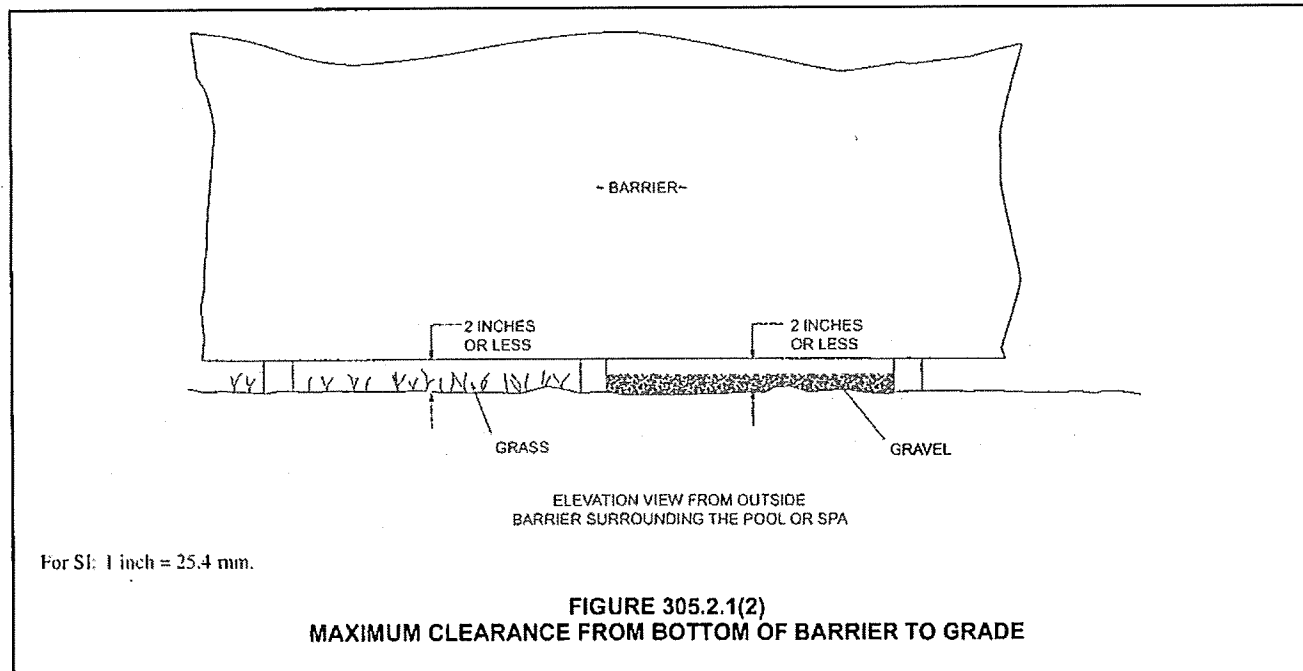
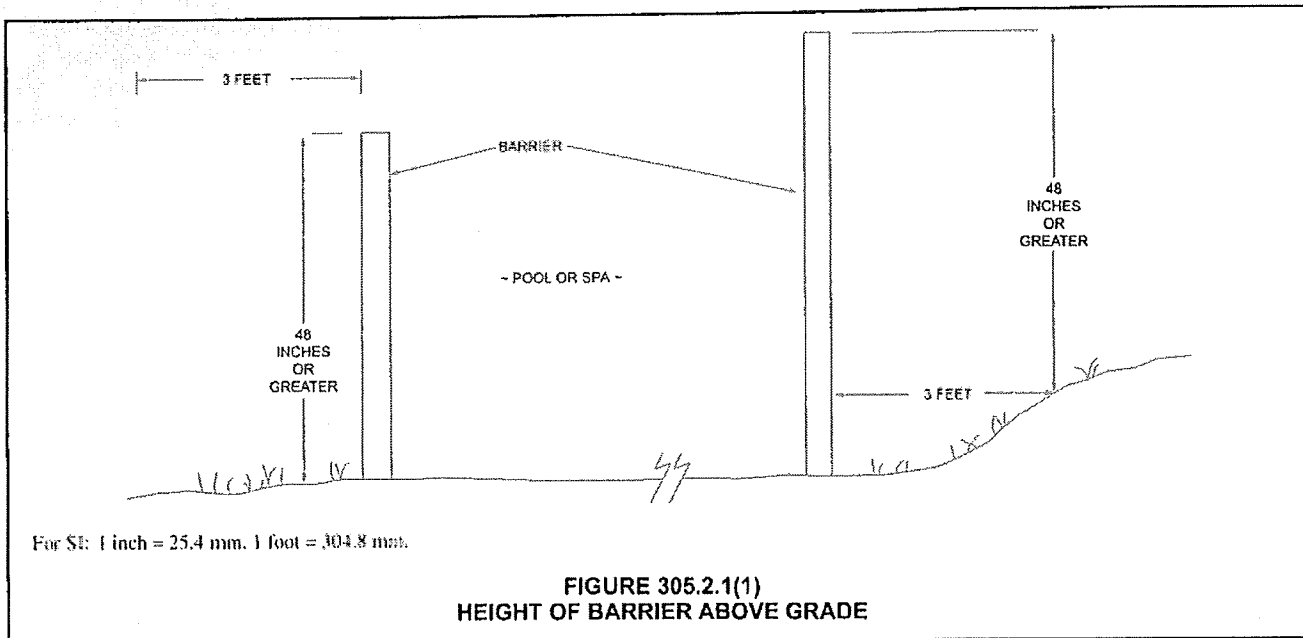

305.2.3 Solid barrier surfaces. Solid barriers that do not have openings shall not contain indentations or protrusions that form handholds and footholds, except for normal construction tolerances and tooled masonry joints.

❖ An important characteristic of a barrier is that the exterior vertical face not offer any protrusions or indentations such that a toehold or handhold could assist in the climbing of the barrier.

305.2.4 Mesh fence as a barrier. Mesh fences, other than chain link fences in accordance with Section 305.2.7, shall be installed in accordance with the manufacturer's instructions and shall comply with the following:

1. The bottom of the mesh fence shall be not more than 1 inch (25 mm) above the deck or installed surface or grade.
2. The maximum vertical clearance from the bottom of the mesh fence and the solid surface shall not permit the fence to be lifted more than 4 inches (102 mm) from grade or decking.
3. The fence shall be designed and constructed so that it does not allow passage of a 4-inch (102 mm) sphere under any mesh panel. The maximum vertical clearance from the bottom of the mesh fence and the solid surface

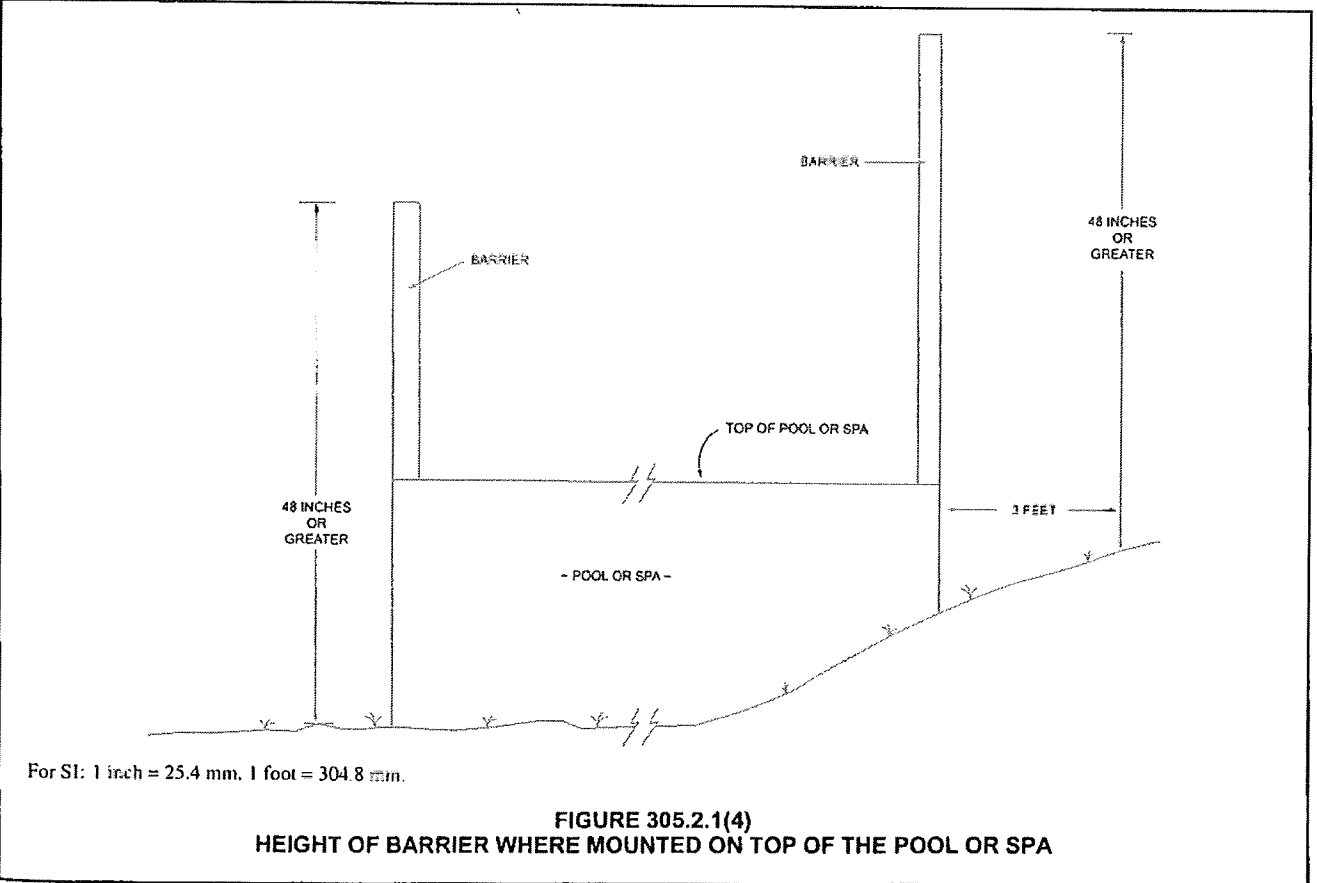
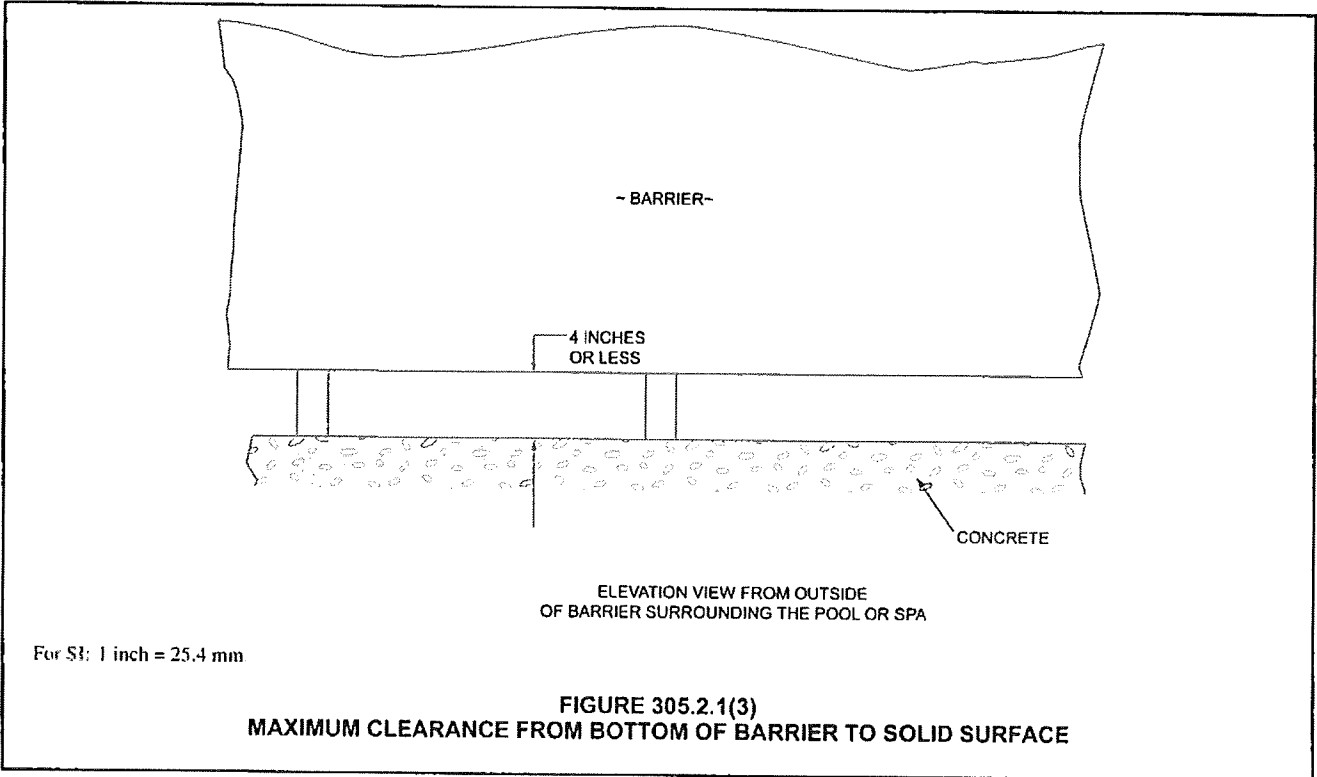

GENERAL COMPLIANCE

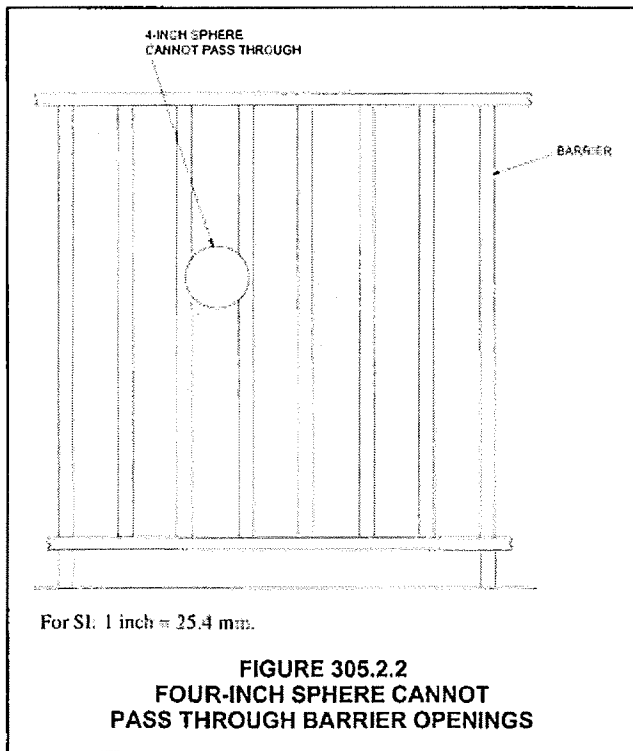
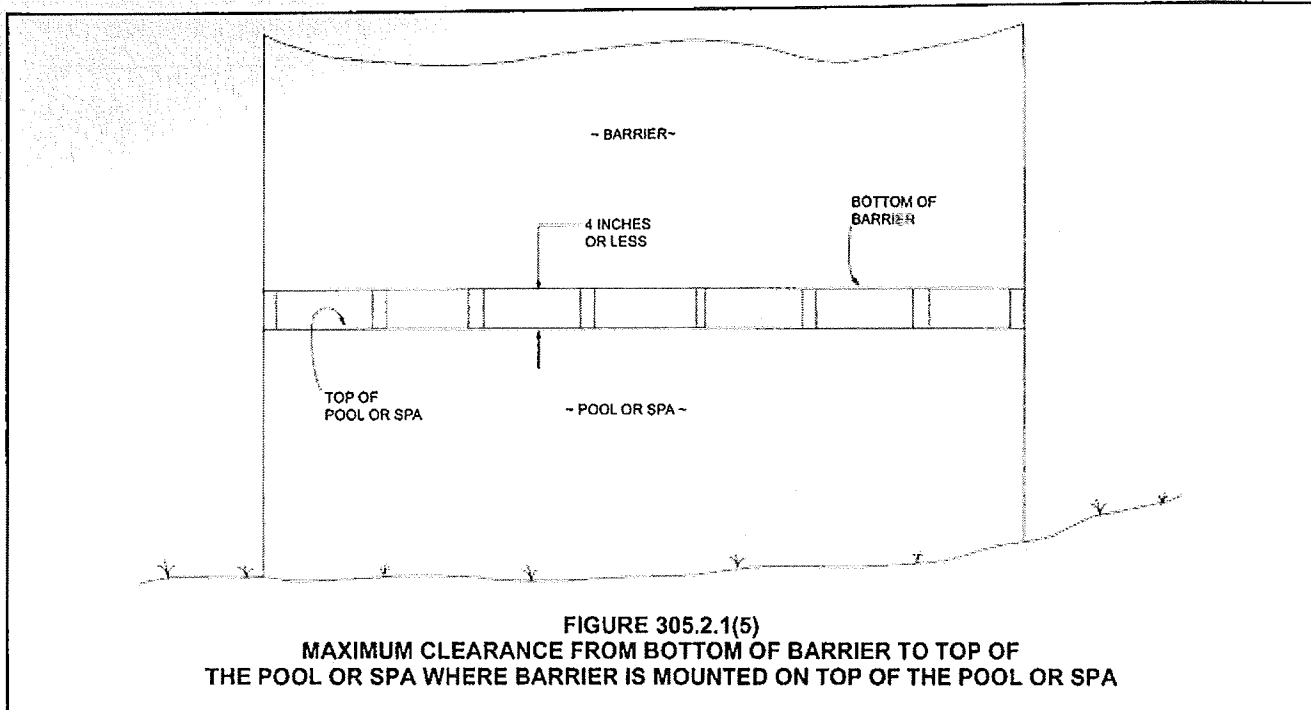

shall not be more than 4 inches (102 mm) from grade or decking.

4. An attachment device shall attach each barrier section at a height not lower than 45 inches (1143 mm) above grade. Common attachment devices include, but are not limited to, devices that provide the security equal to or

greater than that of a hook-and-eye-type latch incorporating a spring-actuated retaining lever such as a safety gate hook.

5. Where a hinged gate is used with a mesh fence, the gate shall comply with Section 305.3.
 6. Patio deck sleeves such as vertical post receptacles that are placed inside the patio surface shall be of a nonconductive material.
 7. Mesh fences shall not be installed on top of onground residential pools.
- ❖ Mesh fences provide a temporary, removable barrier for a pool or spa. For example, consider a pool with a permanent barrier on three sides and the fourth side is bounded by a building. During times when the pool is not in use, a mesh barrier could be erected between the pool and the building so that the space between the building and the mesh fence could be used without concern that the pool could be easily accessed by children. The bottom of the mesh barrier (fence) must not be able to be lifted more than 4 inches (102 mm) above the pool deck so that a child cannot crawl under the barrier. The attachment devices between mesh barrier sections and the posts must be not less than 45 inches (1142 mm) above the deck so that they are out of reach of small children. The attachment devices must offer the same difficulty to disengage as a spring-loaded hook and eye latch. Gates with mesh fences must comply with gate requirements in Section 305.3.

Mesh fences must not be used on top of onground residential pools because mesh fencing cannot resist the forces of an adult falling against it. An adult could

topple off the deck of an above-ground pool and onto the ground below (see Commentary Figure 305.2.4).

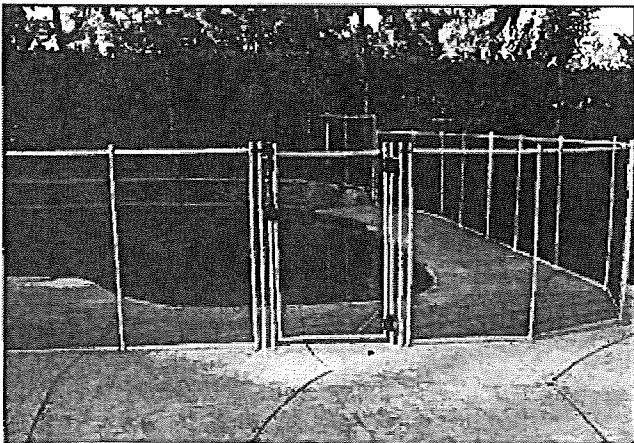

**FIGURE 305.2.4
MESH FENCE AS A STRUCTURE-
TO-POOL BARRIER**

305.2.5 Closely spaced horizontal members. Where the barrier is composed of horizontal and vertical members and the distance between the tops of the horizontal members is less than 45 inches (1143 mm), the horizontal members shall be located on the pool or spa side of the fence. Spacing between vertical members shall not exceed $1\frac{3}{4}$ inches (44 mm) in width. Where there are decorative cutouts within vertical

members, spacing within the cutouts shall not exceed $1\frac{3}{4}$ inches (44 mm) in width.

❖ Conventional fencing that is not chain link fence is typically constructed with horizontal rails attached to vertical posts. Vertical pickets are fastened to the horizontal rails to complete the barrier. If the distance between the top surface of the horizontal rails is less than 45 inches (1143 mm), such spacing could allow a child to climb up and over the barrier. Therefore, these closely spaced rails must be located on the pool or spa side of the barrier so that a child on the outside of the barrier cannot climb over it. Where closely spaced rails exist and are exposed between vertical members on the exterior of the fence, the gap between vertical pickets must not be more than $1\frac{3}{4}$ inches (44 mm) wide so that a child cannot wedge his or her foot in the gap and gain a handhold on the top closely spaced horizontal member in order to scale the fence [see Commentary Figure 305.2.5(1)]. Any decorative cutouts in the pickets must not have an opening greater than $1\frac{3}{4}$ inches (44 mm) for the same reason [see Commentary Figure 305.2.5(2)].

There are welded metal wire mesh products and flexible "on a roll" plastic fence products that "technically comply" with the dimensional requirements of this section. However, this section was written with the typical wood or rigid vinyl fence construction in mind. Consider a wood fence with 4-inch by 4-inch vertical posts with two 2-inch by 4-inch horizontal rails (one near the top, one near the bottom of the fence)

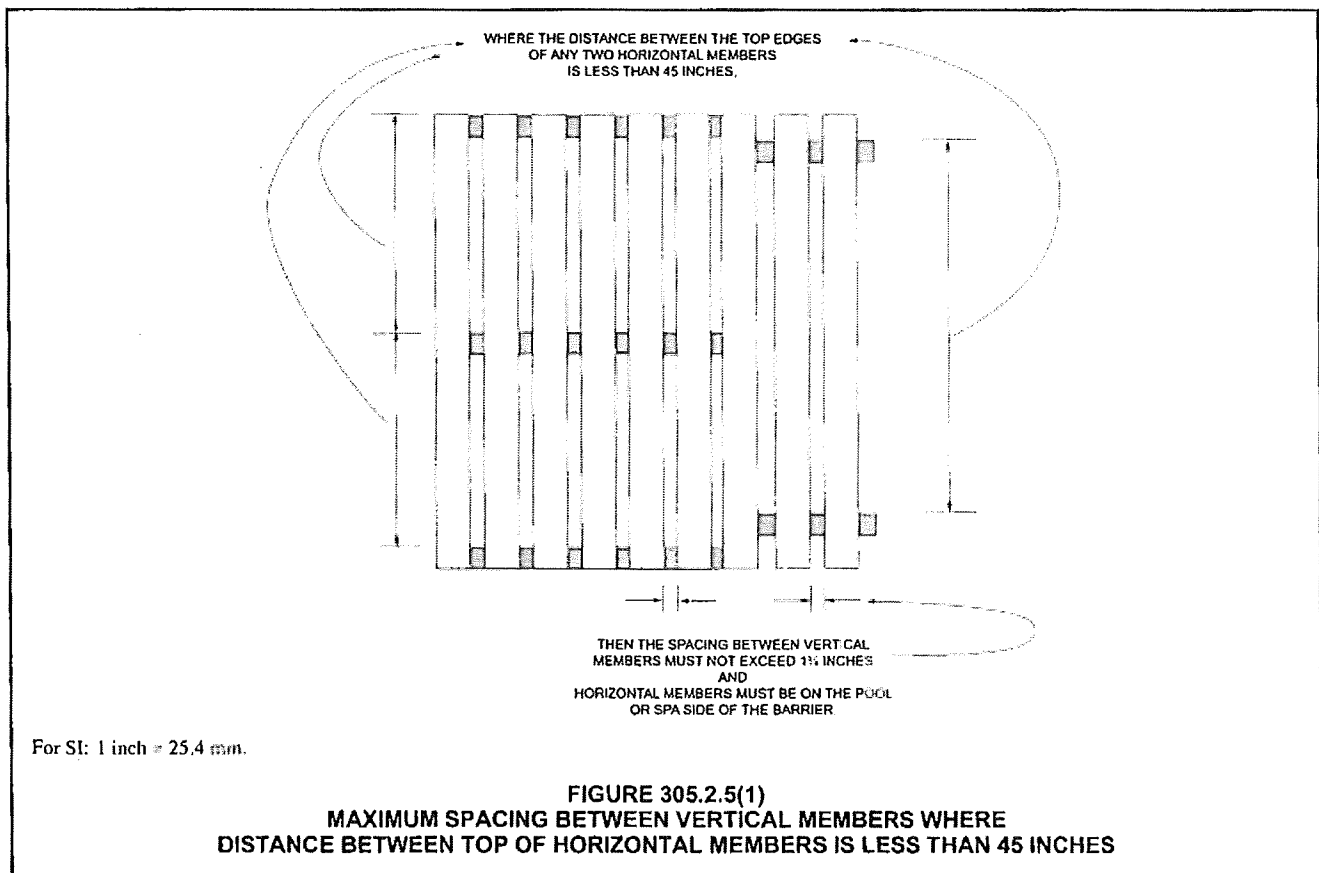

GENERAL COMPLIANCE

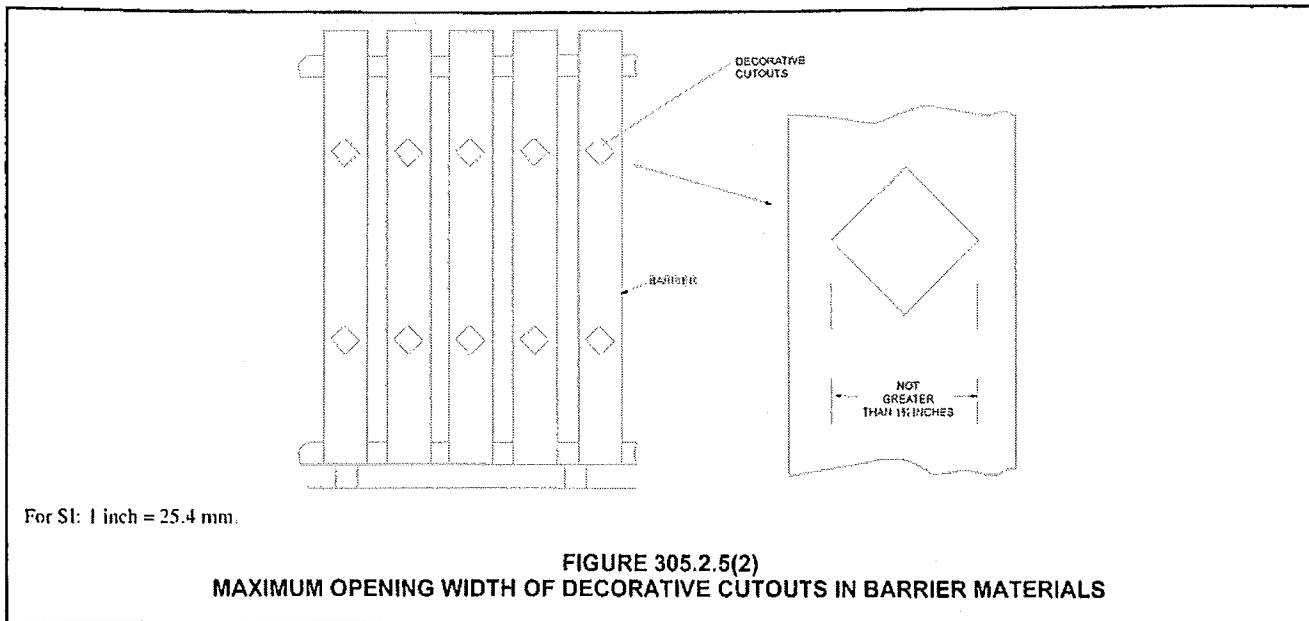

with $\frac{3}{4}$ -inch-thick vertical pickets (4 to 6 inches wide) horizontally spaced apart not more than about the thickness of 2-inch (nominal) material. Such construction has “thickness of its vertical members,” making it difficult to climb. For example, reaching between the pickets to grab onto a 2-inch by 4-inch horizontal rail will be difficult. Similarly, wedging the toe of a shoe between the (thick) pickets to get a toe-hold onto the horizontal rail will be difficult. And generally, such a fence would not be constructed with many closely spaced horizontal rails as it would be too costly and structurally unnecessary.

Do these metal or plastic mesh products with horizontal “members” every 4 inches or closer (but with the width between vertical “members” less than $1\frac{3}{4}$ inches) offer an equivalent resistance to climbing by children? Does such a product offer a similar rigidity and ruggedness to a fence constructed of wood members given that the code does not specify a distance between vertical posts? There are situations where, for public safety, a code official might have to make a decision about items that are not specifically covered by the code. Section 102.8 provides support to the code official in these instances.

305.2.6 Widely spaced horizontal members. Where the barrier is composed of horizontal and vertical members and the distance between the tops of the horizontal members is 45 inches (1143 mm) or more, spacing between vertical members shall not exceed 4 inches (102 mm). Where there are decorative cutouts within vertical members, the interior width of the cutouts shall not exceed $1\frac{3}{4}$ inches (44 mm).

❖ Conventional fencing that is not chain link fencing is typically constructed with horizontal rails attached to vertical posts. Vertical pickets are fastened to the horizontal rails to complete the barrier. If the distance between the top surface of the horizontal rails is greater than or equal to 45 inches (1143 mm), such

spacing poses a climbing difficulty for children. Therefore, these widely spaced rails could be located on either side of the fence. Because there is not a reachable horizontal top member to gain a handhold, the vertical pickets could be spaced as far as 4 inches apart [see Commentary Figure 305.2.6(1)]. However, note that Section 305.2.2 requires that openings in the barrier must not allow the passage of a 4-inch (102 mm) sphere. Any decorative cutouts in the pickets must not have an opening that is greater

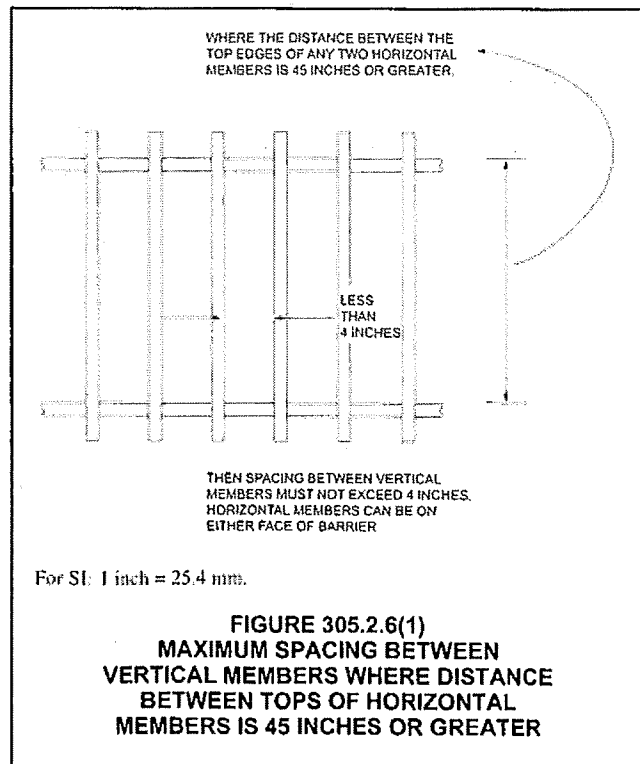

than $1\frac{3}{4}$ inches (44 mm) to prevent a child from gaining a foothold to scale the fence [see Commentary Figure 305.2.5(2)].

Commentary Figure 305.2.6(2) shows a barrier. The fence is known to be 4 feet (1219 mm) high. It is obvious that the distance between the horizontal rails is less than 45 inches (1143 mm) and the vertical pickets spaced wider than 1.75 inches (44 mm). Thus, this fence is a violation because the horizontal members are not at least 45 inches (1143 mm) apart.

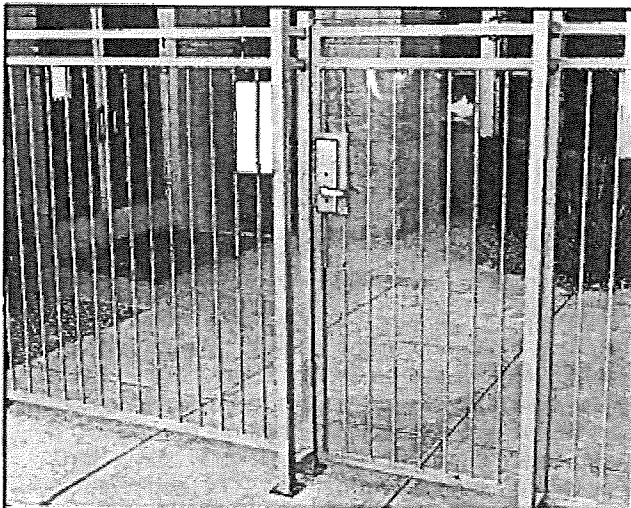
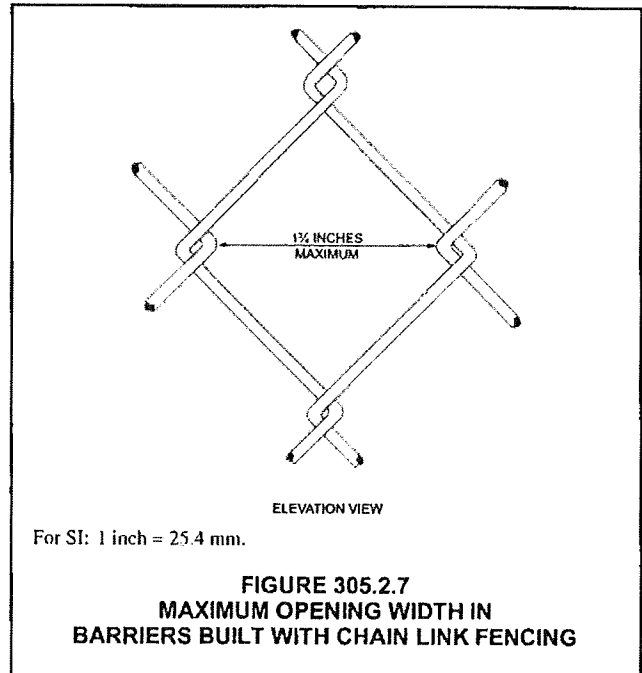

FIGURE 305.2.6(2)
VIOLATION—BARRIER (FENCE) HORIZONTAL MEMBERS TOO CLOSE



305.2.8 Diagonal members. Where the barrier is composed of diagonal members, the maximum opening formed by the diagonal members shall be not more than $1\frac{3}{4}$ inches (44 mm). The angle of diagonal members shall be not greater than 45 degrees (0.79 rad) from vertical.

❖ Some barrier designs use diagonal members (lattice-work) as part of the barrier. Where diagonal members are installed, the angle cannot be more than 45 degrees (0.79 rad) from vertical and the opening created by the diagonal members cannot be greater than $1\frac{3}{4}$ inches (44 mm) so a child cannot wedge a foot in the opening to climb the barrier (see Commentary Figure 305.2.8).

305.2.7 Chain link dimensions. The maximum opening formed by a chain link fence shall be not more than $1\frac{3}{4}$ inches (44 mm). Where the fence is provided with slats fastened at the top and bottom which reduce the openings, such openings shall be not more than $1\frac{3}{4}$ inches (44 mm).

❖ Chain link fencing has diamond-shaped or square openings. The most common sizes of chain link openings (measured between parallel sides of the opening) are 2 inches (51 mm) and $2\frac{1}{4}$ inches (57 mm). This section requires that the openings be not greater than $1\frac{3}{4}$ inches (44 mm) so that a child cannot wedge his or her foot in the opening in order to climb the fence (see Commentary Figure 305.2.7). Two-inch (51 mm) and $2\frac{1}{4}$ -inch (57 mm) chain link fence must have the openings reduced in size by the installation of slats (sometimes called privacy slats) vertically or diagonally. Where slats are used, they must be attached to the top and bottom of the fence so that they cannot be removed for gaining a hand- or foothold on the fence. The slats must be of a width that reduces the openings to less than $1\frac{3}{4}$ inches (44 mm).

Chain link fencing is also available in $1\frac{1}{4}$ -inch (32 mm) size (mesh). The resulting diagonal opening is $1\frac{3}{4}$ inches (44 mm). Therefore, slats would not be required for this size of chain link fence.

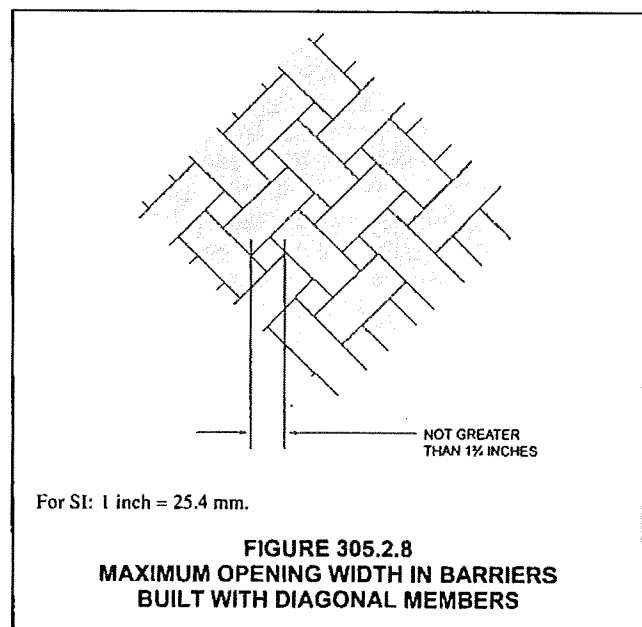

GENERAL COMPLIANCE

305.2.9 Clear zone. There shall be a clear zone of not less than 36 inches (914 mm) between the exterior of the barrier and any permanent structures or equipment such as pumps, filters and heaters that can be used to climb the barrier.

- ❖ A barrier of any height is not much of a deterrent to gaining access to the pool or spa if there is equipment, trees or storage boxes that are within 3 feet (914 mm) of the outside of the barrier. These items could be used to assist someone in climbing over the barrier.

305.2.10 Poolside barrier setbacks. The pool or spa side of the required barrier shall be not less than 20 inches (508 mm) from the water's edge.

- ❖ Barriers must not be installed so close to the pool or spa such that if a child did manage to climb over the barrier, he or she would not immediately fall into the water.

305.3 Gates. Access gates shall comply with the requirements of Sections 305.3.1 through 305.3.3 and shall be equipped to accommodate a locking device. Pedestrian access gates shall open outward away from the pool or spa, shall be self-closing and shall have a self-latching device.

- ❖ There can be two types of gates in a barrier: a service access gate, which is required by Section 305.3.1 to be secured by a lock, and a pedestrian gate for user access to the pool or spa. This section requires that pedestrian gates open outward, self-close and self-latch so that the barrier is continuous all around the pool or spa after a user passes through the gate. The code is not specific as to the conditions whereby the gate must be self-closing and self-latching. Wind, degree of opening and instability of the barriers and gate could affect the closing and latching of the gate. The code official will have to use his or her best judgment concerning this section. Commentary Figure 305.3 shows a pedestrian access gate that swings in the wrong direction.

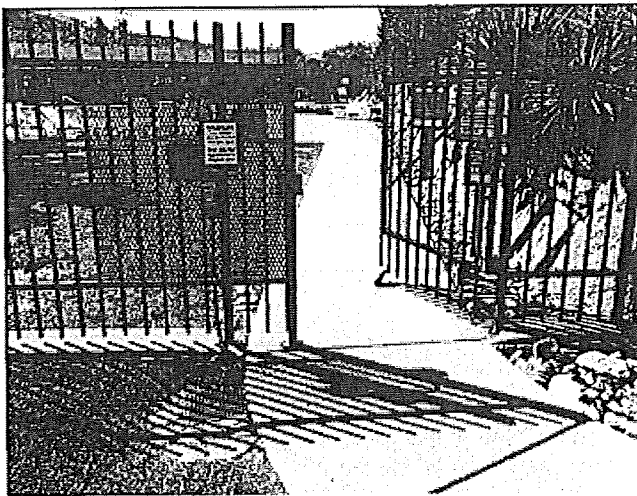

FIGURE 305.3
VIOLATION—WRONG SWING DIRECTION ON
PEDESTRIAN ACCESS GATE

Some code officials might consider an outdoor public pool and spa area a location where "means of egress," as defined by the IBC, applies. Section 1010 of the IBC pertaining to doors and gates has requirements for self-closing and self-latching doors (of which the IBC considers gates as doors).

305.3.1 Utility or service gates. Gates not intended for pedestrian use, such as utility or service gates, shall remain locked when not in use.

- ❖ This section requires that service gates be locked when not in use.

305.3.2 Double or multiple gates. Double gates or multiple gates shall have at least one leaf secured in place and the adjacent leaf shall be secured with a self-latching device. The gate and barrier shall not have openings larger than $\frac{1}{2}$ inch (12.7 mm) within 18 inches (457 mm) of the latch-release mechanism. The self-latching device shall comply with the requirements of Section 305.3.3.

- ❖ In some cases, gates could be installed with several movable (swinging) sections. One swinging section must be provided with a self-latching device that is located on the pool or spa side of the gate. The other portions of the gate must be secured so that they are normally stationary. For example, the normally stationary side of the gate might be prevented from swinging by a sliding rod mounted on the gate that can penetrate into a hole in the deck or walkway. The latch on the other gate must be of the self-latching type and must be on the pool or spa side of the gate. The inside release mechanism must be protected against tampering from the outside of the gate by providing a solid panel or mesh with openings of not greater than $\frac{1}{2}$ inch (12.7 mm). The panel or small opening mesh must extend not less than 18 inches (457 mm) in all directions (except not beyond the top of the required gate height) of the inside latch-release mechanism (refer to the commentary to Section 305.3.3).

305.3.3 Latches. Where the release mechanism of the self-latching device is located less than 54 inches (1372 mm) from grade, the release mechanism shall be located on the pool or spa side of the gate not less than 3 inches (76 mm) below the top of the gate, and the gate and barrier shall not have openings greater than $\frac{1}{2}$ inch (12.7 mm) within 18 inches (457 mm) of the release mechanism.

- ❖ This section requires that the gate's latch-release mechanism on the nonpool or spa side of the gate be not less than 54 inches (1372 mm) above grade or, if less than 54 inches (1372 mm), then the release mechanism must be on the pool or spa side of the gate. Placing the release mechanism at 54 inches (1372 mm) puts the release out of reach of small children. But there may be aesthetic reasons for having the latch at less than 54 inches (1372 mm) above grade. Where located on the pool or spa side of the gate, the latch must be not less than 3 inches (76 mm) below the top of the gate. This allows for adults outside of the gate to reach the release but preventing children outside the gate from reaching the latch

release. The inside (backside of the gate) release mechanism must be protected against tampering from the outside of the gate by providing a solid panel or mesh with openings of not greater than 1/2 inch (12.7 mm). The panel or small opening mesh must extend not less than 18 inches (457 mm) in all directions of the inside latch-release mechanism [see Commentary Figure 305.3.3(1)].

This section reflects the "traditional approach" for latch-release mechanisms on pedestrian access gates to pool and spa areas. Although suitable for most residential (as defined by this code) pool and spa access gates, this approach might not coordinate with designs for accessibility and controlled access needs in a public environment. For example, a latch-release on the inside (backside) of the gate or at a 54-inch height above the walking surface on either side of a gate is out of the reach range for persons seated in a wheelchair. Key card or key entry might also be necessary to control when the pool or spa can be used and who can use the pool or spa [see Commentary Figure 305.3.3(2)]. Therefore, the designer of the barrier system and pedestrian access gate for a public environment will need to assess each gate arrangement against all code requirements

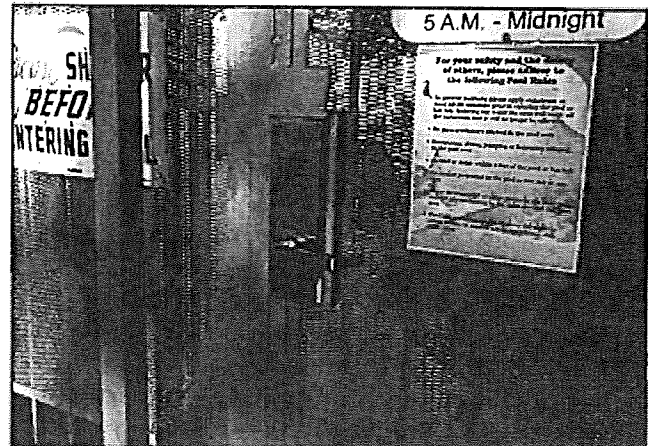
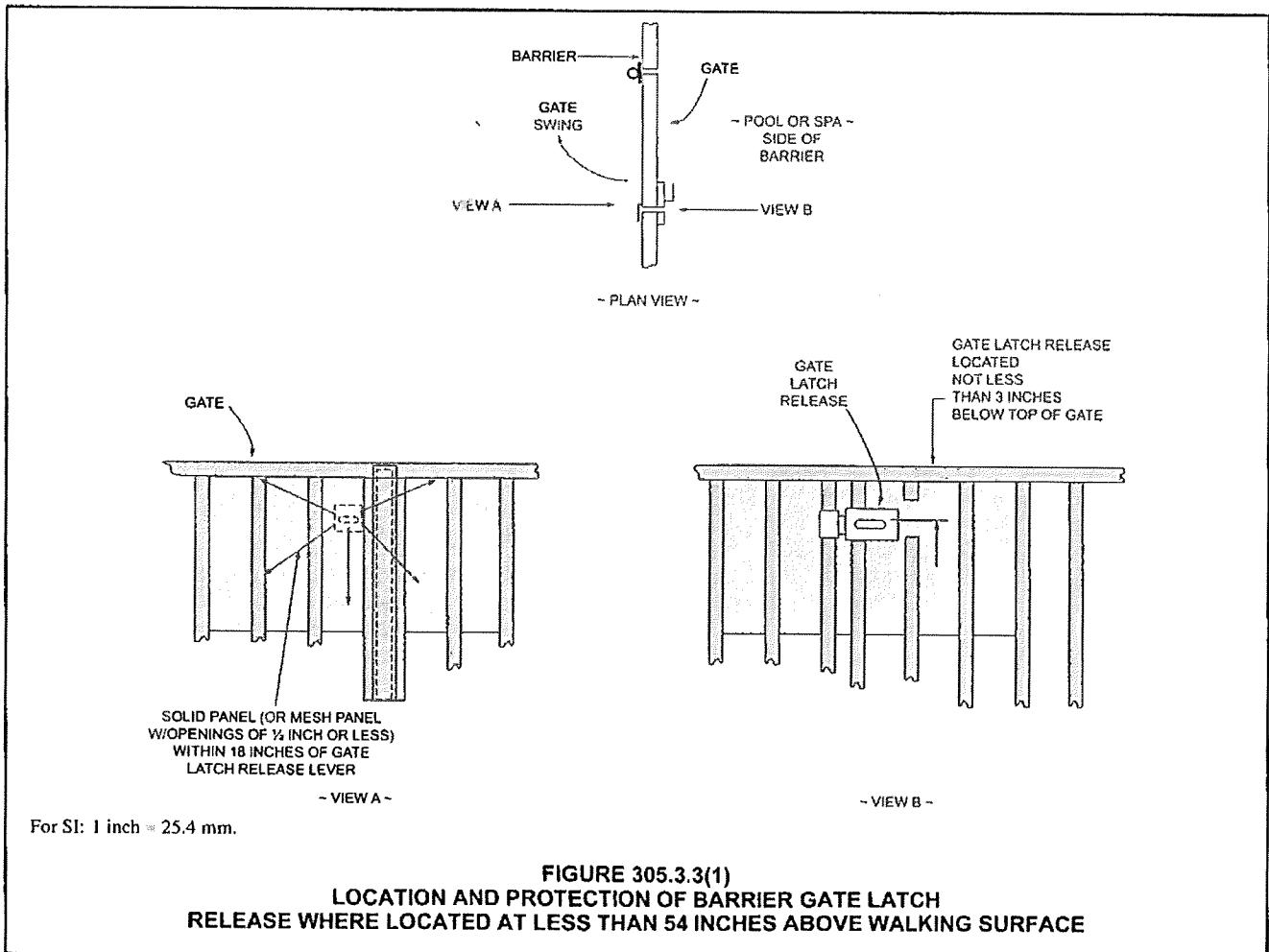

FIGURE 305.3.3(2)
KEY CARD ENTRY ON GATE TO POOL AND SPA AREA MIGHT REQUIRE ALTERNATIVE METHOD APPROVAL

and the needs of the client in order to propose an alternative method to the code official for compliance to this section (see Section 104.11).



305.4 Structure wall as a barrier. Where a wall of a dwelling or structure serves as part of the barrier and where doors or windows provide direct access to the pool or spa through that wall, one of the following shall be required:

1. Operable windows having a sill height of less than 48 inches (1219 mm) above the indoor finished floor and doors shall have an alarm that produces an audible warning when the window, door or their screens are opened. The alarm shall be *listed* and *labeled* as a water hazard entrance alarm in accordance with UL 2017. In dwellings or structures not required to be Accessible units, Type A units or Type B units, the operable parts of the alarm deactivation switches shall be located 54 inches (1372 mm) or more above the finished floor. In dwellings or structures required to be Accessible units, Type A units or Type B units, the operable parts of the alarm deactivation switches shall be located not greater than 54 inches (1372 mm) and not less than 48 inches (1219 mm) above the finished floor.
 2. A *safety cover* that is *listed* and *labeled* in accordance with ASTM F1346 is installed for the pools and spas.
 3. An *approved* means of protection, such as self-closing doors with self-latching devices, is provided. Such means of protection shall provide a degree of protection that is not less than the protection afforded by Item 1 or 2.
- ❖ A building wall can serve as part of the barrier. Where that building wall has openings such as doors or operable windows, those openings can provide access to the pool or spa by a child. If the wall has only operable windows and those windowsill heights are 48 inches (1219 mm) or more above the inside floor of the structure, then the wall provides a similar level of protection that a 48-inch-high (1219 mm) barrier does. Although furniture could be placed against that wall that could aid in a child gaining access to the window, the code official can only be concerned about the height of the window above what is considered to be a permanent and "normal" walking surface. The code official doesn't have any control over the placement of furniture in a building. Walking surfaces would include, for example, permanent stairs and landings intersecting walls having operable windows. However, a kitchen countertop with windows just above the countertop would not be considered a "normal" walking surface even though a child might use kitchen drawers to climb to the countertop to access the window.

If the operable windowsill heights are lower than 48 inches (1219 mm) above the floor, either screen or window alarms listed and labeled to UL 2017 must be installed; or a safety cover listed and labeled to ASTM F1346 must be provided for the pool or spa [see Commentary Figure 305.4(1)].

Where there is a door in the wall, either a door alarm listed and labeled to UL 2017 must be installed; or a safety cover listed and labeled to ASTM F1346 must be provided for the pool or spa. A third option

for a door could be to provide a self-closing and self-latching door with a latch-release mechanism that is not less than 54 inches (1372 mm) above the floor, but this option requires approval by the code official.

Where a door or window alarm is installed, the deactivation switches must be not less than 54 inches (1372 mm) above the floor [see Commentary Figure 305.4(2)]. This height corresponds to the same height required for latch-release mechanisms for gates in Section 305.3.3. Where the structure is required to be an Accessible unit, a Type A accessible unit or a Type B accessible unit, the deactivation switch height can be reduced to 48 inches (1219 mm) above the floor to be within upper reach range of persons seated in a wheelchair. Accessible units, Type A accessible units and Type B accessible units are defined in the IBC.

Note that Item 2 does not specify that pools are required to have a powered safety cover in compliance with ASTM F1346. A manual safety cover is the minimum requirement. This is in contrast to Exception 2 in Section 305.1 for not requiring a barrier around the pool. If there is a barrier around the pool (perhaps a structure forms part of that barrier) or the pool has a powered safety cover, then the public at large is kept safe. The requirement for a safety cover (manual type as a minimum) for relief of the alarm requirement for doors and windows for a structure serving as part of the barrier is more for the occupants (including their children) of the structure. It is then a personal decision by the occupant as to whether they will install the safety cover to protect their children. The code intends that the means for safety be provided to the occupant—the code official cannot make the occupant use those means. Commentary Figure 305.1(4) shows a manual installed safety cover (however, it is unknown whether what is shown meets ASTM F1346). Note the barrier (fence) in the background on the left of the photo.

305.5 Onground residential pool structure as a barrier. An onground *residential* pool wall structure or a barrier mounted on top of an onground *residential* pool wall structure shall serve as a barrier where all of the following conditions are present:

1. Where only the pool wall serves as the barrier, the bottom of the wall is on grade, the top of the wall is not less than 48 inches (1219 mm) above grade for the entire perimeter of the pool, the wall complies with the requirements of Section 305.2 and the pool manufacturer allows the wall to serve as a barrier.
2. Where a barrier is mounted on top of the pool wall, the top of the barrier is not less than 48 inches (1219 mm) above grade for the entire perimeter of the pool, and the wall and the barrier on top of the wall comply with the requirements of Section 305.2.
3. Ladders or steps used as means of access to the pool are capable of being secured, locked or removed to prevent

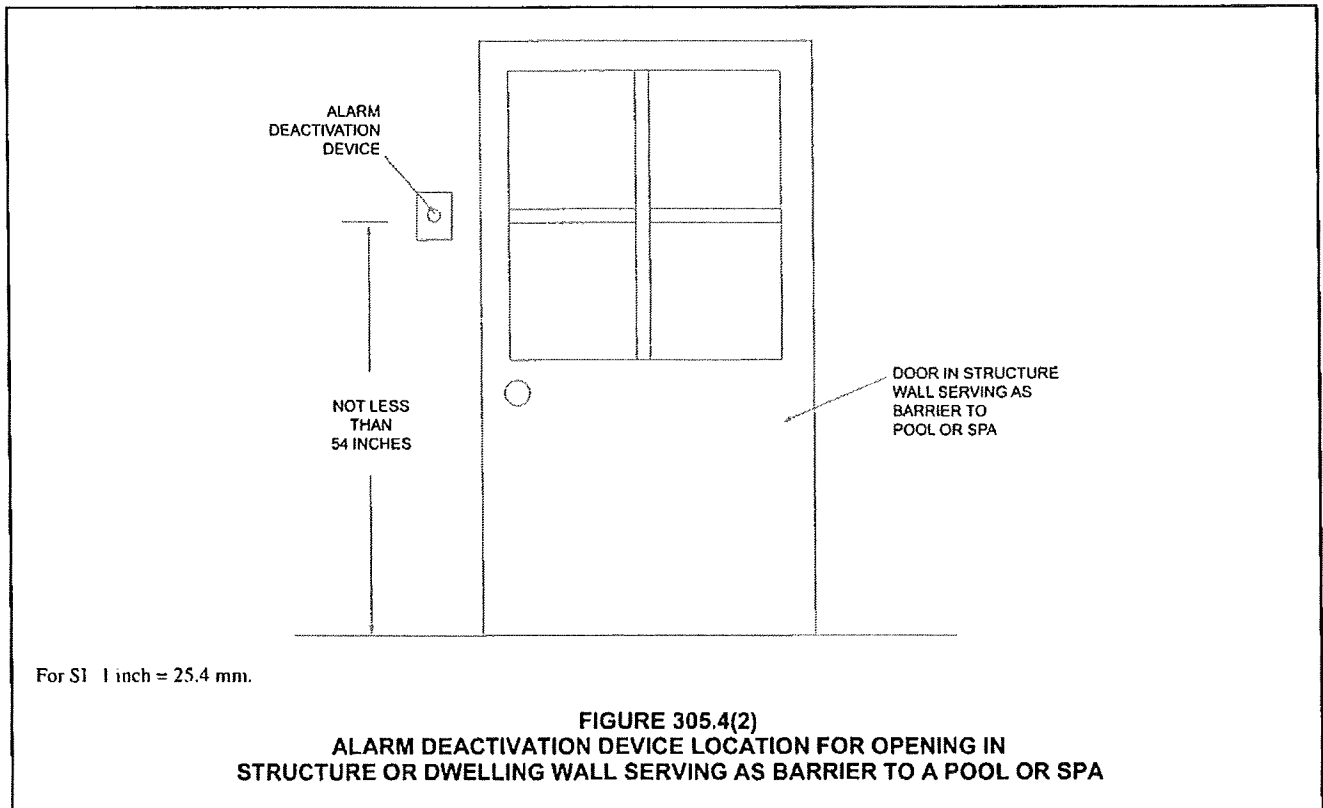
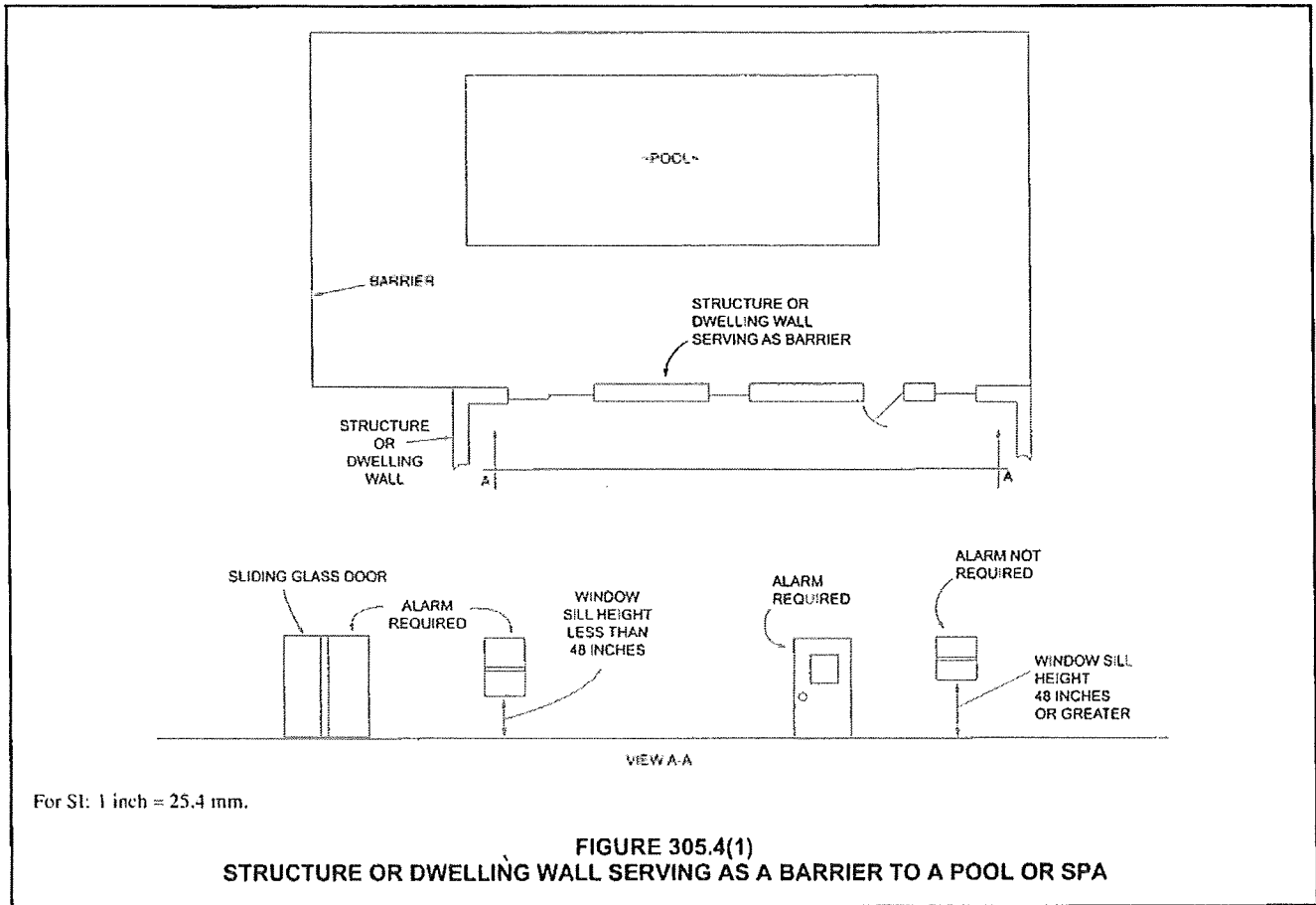

GENERAL COMPLIANCE

access except where the ladder or steps are surrounded by a barrier that meets the requirements of Section 305.

4. Openings created by the securing, locking or removal of ladders and steps do not allow the passage of a 4-inch (102 mm) diameter sphere.
 5. Barriers that are mounted on top of onground *residential* pool walls are installed in accordance with the pool manufacturer's instructions.
- ❖ Onground pools that have the top of the structure at 48 inches (1219 mm) or more above grade around the entire perimeter can serve as their own barrier from entry to the vessel. In order to serve as the barrier, all the requirements of Section 305.2 must be met; for example, a clear zone of 36 inches (914 mm) around the vessel and the outside of the pool wall cannot be climbable by children. Because the pool is above ground, a stairway or ladder is needed to access the vessel. Such ladders or stairways must be either removable or locked in some manner so that children cannot access the vessel. Any resulting opening from the removal or securing of a stairway must not leave openings where a 4-inch sphere (102 mm) will pass through. Barriers for stairways are provided by the manufacturer of the stairway, so the installation of such barriers must be in accordance with the manufacturer's instructions.

305.6 Natural barriers. In the case where the pool or spa area abuts the edge of a lake or other natural body of water, public access is not permitted or allowed along the shoreline, and required barriers extend to and beyond the water's edge not less than 18 inches (457 mm), a barrier is not required between the natural body of water shoreline and the pool or spa.

❖ Although natural bodies of water are not a barrier, they can restrict access to pools and spas by a child simply because he or she would have to navigate through not less than 18 inches (457 mm) depth of the natural body of water before reaching the pool or spa. If the child is successful, there is a low probability that he or she will have difficulty in the pool and spa water.

305.7 Natural topography. Natural topography that prevents direct access to the pool or spa area shall include but not be limited to mountains and natural rock formations. A natural barrier approved by the governing body shall be acceptable provided that the degree of protection is not less than the protection afforded by the requirements of Sections 305.2 through 305.5.

❖ Natural topography could present significant difficulty for children to access the pool and spa. For example, a pool or spa area that is adjacent to a steep and rocky hillside might be too treacherous for anyone to traverse, let alone a child. However, the code official must approve such arrangements to allow elimination of a barrier or portion thereof.

SECTION 306 DECKS

306.1 General. Decks shall be designed and installed in accordance with the *International Residential Code* or the *International Building Code*, as applicable in accordance with Section 102.7.1, except as provided in this section.

❖ The design and construction of decks must follow the requirements of the IBC or IRC, as applicable, and the requirements of this section.

306.2 Slip resistant. Decks, ramps, coping, and similar step surfaces shall be slip resistant and cleanable. Special features in or on decks such as markers, brand insignias, and similar materials shall be slip resistant.

❖ The presence of water on a walking surface significantly increases the slip potential. Special attention must be given to markers and insignias to make sure that they do not present an increased slip hazard.

306.3 Step risers and treads. Step risers for decks of public pools and spas shall be uniform and have a height not less than $3\frac{1}{4}$ inches (95 mm) and not greater than $7\frac{1}{2}$ inches (191 mm). The tread distance from front to back shall be not less than 11 inches (279 mm). Step risers for decks of *residential* pools and spas shall be uniform and shall have a height not exceeding $7\frac{1}{2}$ inches (191 mm). The tread distance from front to back shall be not less than 10 inches (254 mm).

❖ Step riser heights and tread depths are slightly different for decks associated with pools and spas, depending on whether they are associated with the IBC or the IRC.

306.4 Deck steps handrail required. Public pool and spa deck steps having three or more risers shall be provided with a handrail.

❖ For three or more steps associated with a pool or spa deck for a public pool or public spa, a handrail is needed. There is not a similar requirement for steps associated with pool or spa decks for residential pools or spas, noting the definition of "residential" in Chapter 2. Note that the IRC does require handrails for stairways with four or more risers where the stairway is part of the means of egress for an IRC building (see IRC Section 311). However, not all exterior doors (such as a sliding patio door) of an IRC building are intended to be means of egress doors.

306.5 Slope. The minimum slope of decks shall be in accordance with Table 306.5 except where an alternative drainage method is provided that prevents the accumulation or pooling of water. The slope for decks, other than wood decks, shall be not greater than $\frac{1}{2}$ inch per foot (1 mm per 24 mm) except for ramps. The slope for wood and wood/plastic composite decks shall be not greater than $\frac{1}{4}$ inch per 1 foot (1 mm per 48 mm). Decks shall be sloped so that standing water will not be deeper than $\frac{1}{8}$ inch (3.2 mm), 20 minutes after the cessation of the addition of water to the deck.

❖ Decks around pools and spas must be sloped to drain excess water. Puddles of water deeper than $\frac{1}{8}$

